

- Supports CH5 & CH9
- Low Power Consumption
- High Precision in Position & Ranging

## Product Specification

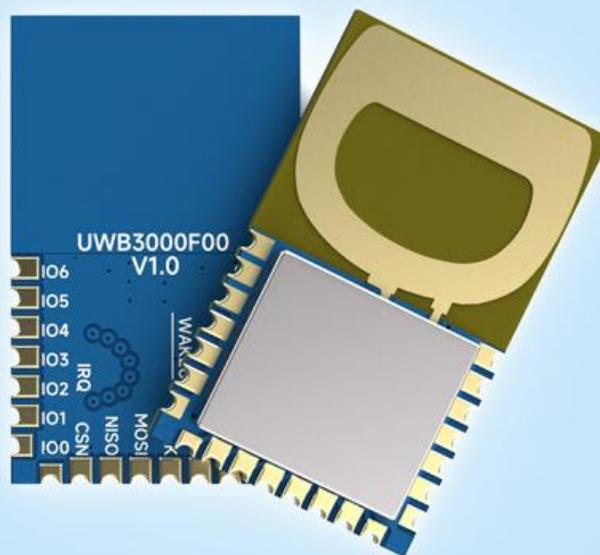

## Catalogue

1. Production Description .....	- 3 -
2. Feature .....	- 3 -
3. Applications .....	- 3 -
4. Block Diagram .....	- 3 -
5. Parameters .....	- 4 -
6. Typical Application Circuit .....	- 4 -
7. Pin Assignment .....	- 5 -
8. Suggestions for Antenna Layout .....	- 6 -
9. Dimension (Unit: mm) .....	- 7 -
Appendix: Reflow Chart for SMT Technology .....	- 8 -

### Note: Revision History

Revision	Date	Comment
V1.0	2023-9	1 <sup>st</sup> Release
V1.1	2023-12	Update part of the description

## 1. Production Description

UWB3000F00 adopted Qorvo's DW3000 , designed with PCB Antenna . UWB3000 is in line with IEEE802.15.4-2015 and IEEE802.15.4z (BPRF mode). It can be used for two-way ranging, TDOA and PDOA systems, positioning accuracy of 10 cm

## 2. Feature

- IEEE802.15.4-2015 UWB
- IEEE802.15.4z (BPRF mode)
- Supports channels 5 & 9 (6489.6 MHz & 7987.2 MHz)
- Data rates of 850 kbps and 6.8 Mbps
- Integrated HW AES 256
- Worldwide UWB Radio
- Regulatory compliance
- Packet length up to 1023 bytes
- Supports 2-way ranging, TDoA and PDoA location schemes
- Programmable output power
- Provides precision location and data transfer simultaneously
- Asset location to an accuracy of 10 cm
- Low power consumption for coin cell applications

## 3. Applications

- Precision real time location systems (RTLS) using two-way ranging, TDoA or PDoA schemes in a variety of markets: Healthcare\ Consumer\ Industrial\ Automotive
- Location aware wireless sensor networks
- Presence detection for secure entry and secure payment

## 4. Block Diagram

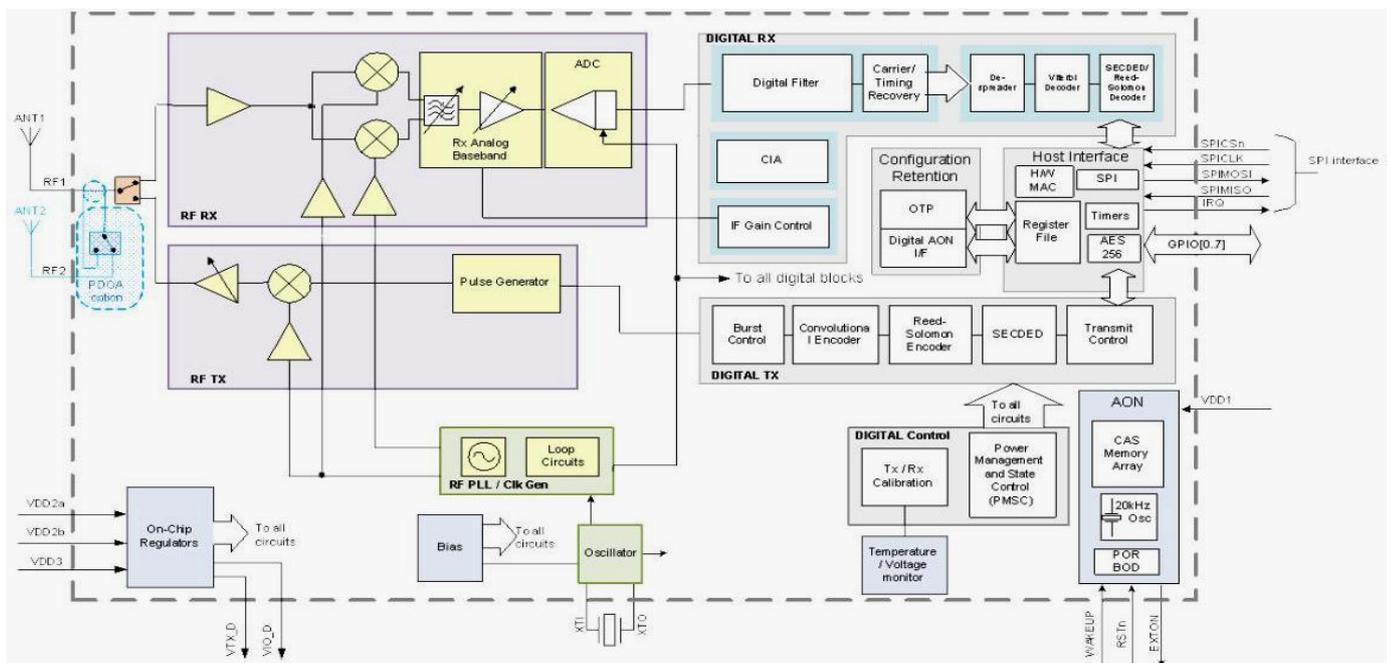

## 5. Parameters

Parameter	Condition	Min.	Typ.	Max.	Unit
Supply Voltage		2.4	3.3	3.6	V
Operating Temperature Range		- 40	25	85	°C
Frequency Range	CH5		6489.6		MHz
	CH9		7987.2		MHz
RF Data Rate		850k		6.8M	bps
Current Consumption					
Sleep Mode			< 1		uA
Rx CH5			72		mA
Rx CH9			88		mA
Tx			69		mA
TX for range measurement			21		mA
Transmit parameters					
Tx Power	@VCC=3.3V	-30		0	dBm
Tx Bandwidth (BW)			499.2		MHz
Receive parameters					
Rx Sensitivity	@850Kbps		-100		dBm
	@6.8Mbps		-94		dBm

## 6. Typical Application Circuit

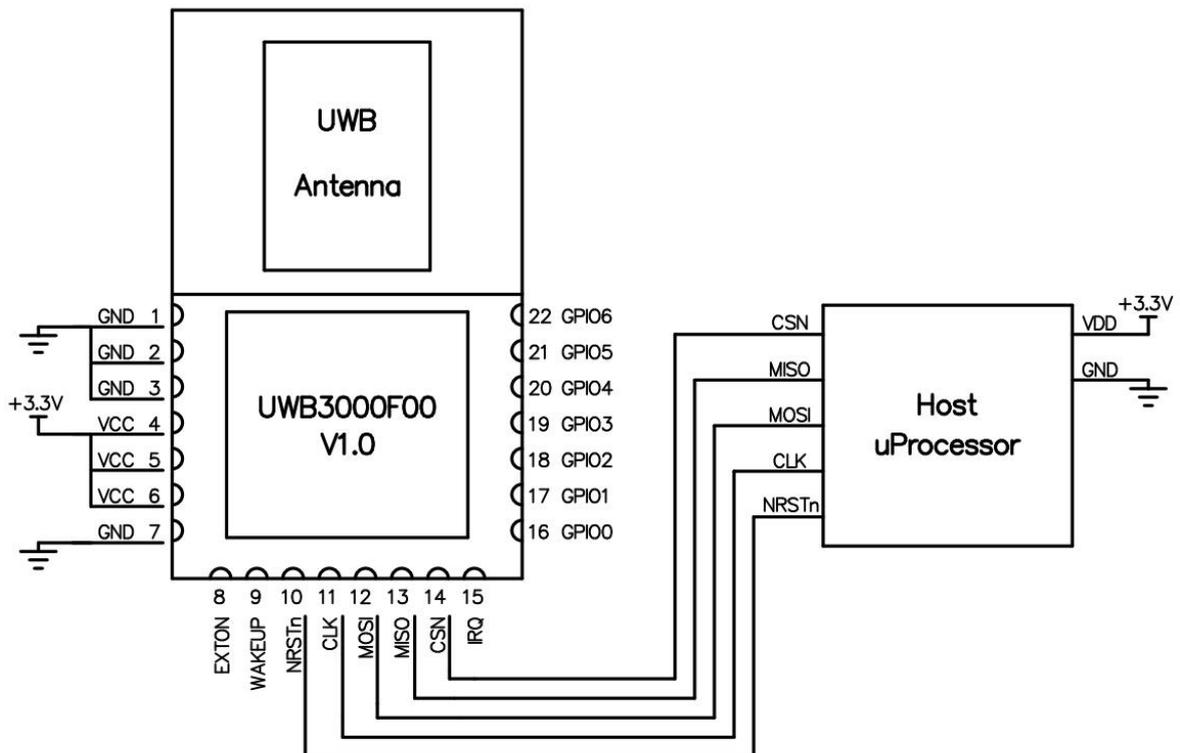

## 7. Pin Assignment

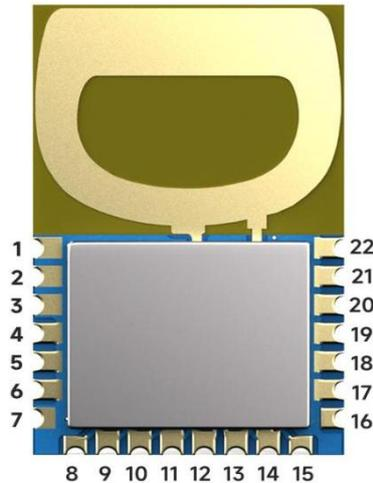

Pin No.	Pin definition	I/O	Description
1,2,3,7	GND		Ground
4,5,6	VCC		VCC (2.4-3.6v)
8	EXTON	DO	External device enable. Asserted during wake up process and held active until device enters sleep mode. Can be used to control external DC-DC converters or other circuits that are not required when the device is in sleep mode so as to minimise power consumption.
9	WAKEUP	DI	When asserted into its active high state, the WAKEUP pin brings the DW3000 out of SLEEP or DEEPSLEEP states into operational mode. This should be connected to ground if not used.
10	NRSTn	DIO	Reset pin. Active Low Output. May be pulled low by external open drain driver to reset the DW3000. Must not be pulled high by external source.
11	CLK	DI	SPI peripheral clock input.
12	MOSI	DI	SPI peripheral data input.
13	MISO	DO	SPI peripheral data output.
14	CSN	DI	SPI chip select. This is an active low enable input. The high-to-low transition on SPICSn signals the start of a new SPI transaction. SPICSn can also act as a wake-up signal to bring DW3000 out of either SLEEP or DEEPSLEEP states.
15	IRQ	DI	Interrupt request output from the DW3000 to the host processor. By default IRQ is an active-high output but may be configured to be active low if required. For correct operation in SLEEP and

			DEEPSLEEP modes it should be configured for active high operation. This pin will float in SLEEP and DEEPSLEEP states and may cause spurious interrupts on the host unless pulled low externally (100kΩ recommended). When the IRQ functionality is not being used the pin may be reconfigured as a general purpose I/O line2 , GPIO8.
16	GPIO0	DIO	GPIO0 from DW3000.
17	GPIO1	DIO	GPIO1 from DW3000.
18	GPIO2	DIO	GPIO2 from DW3000.
19	GPIO3	DIO	GPIO3 from DW3000.
20	GPIO4	DIO	GPIO4 from DW3000.
21	GPIO5	DIO	GPIO5 from DW3000.
22	GPIO6	DIO	GPIO6 from DW3000.

## 8. Suggestions for Antenna Layout

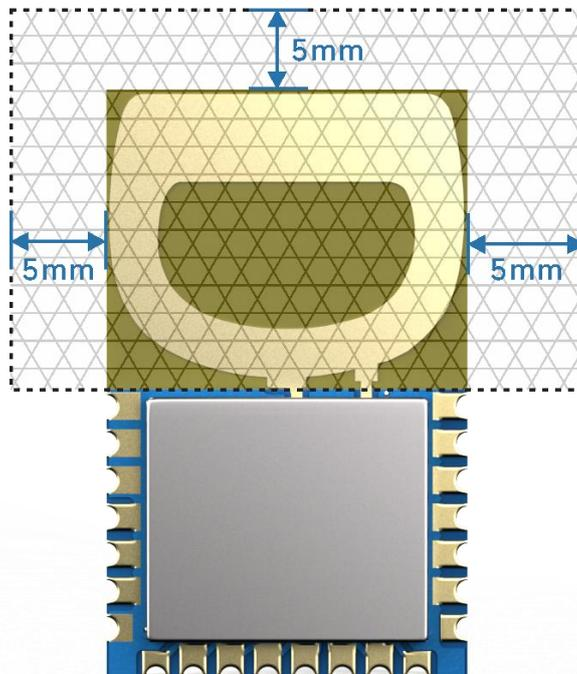

### 1、 Suggestions when use PCB antennas,

Plan 1: Place the module on the edge of the motherboard, and the antenna area extends out the edge of the motherboard

Plan 2: Place the module on the edge of the motherboard, the edge of the motherboard is empty at an antenna location, and it is recommended to be greater than the antenna size 5mm.

2、 In order to meet the performance of the plate antenna, the metal parts are prohibited within 5mm around the antenna, and leave away from high-frequency devices.

**9. Dimension (Unit: mm)**

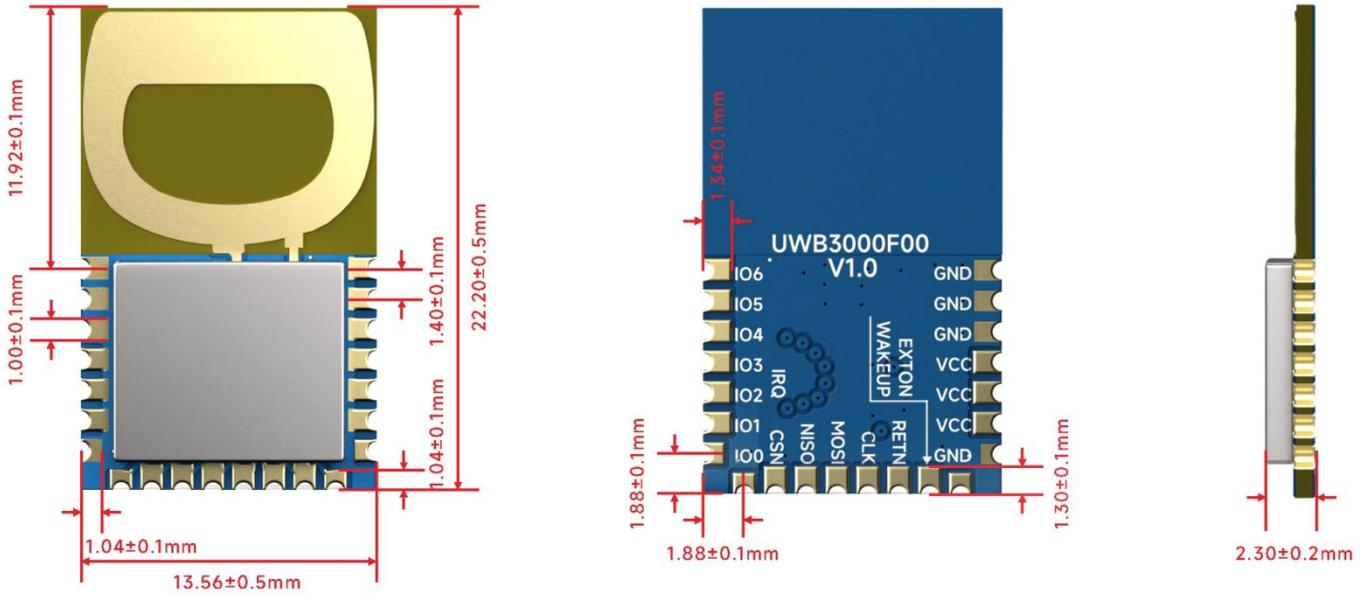

## Appendix: Reflow Chart for SMT Technology

We recommend you should obey the IPC related standards in setting the reflow profile:

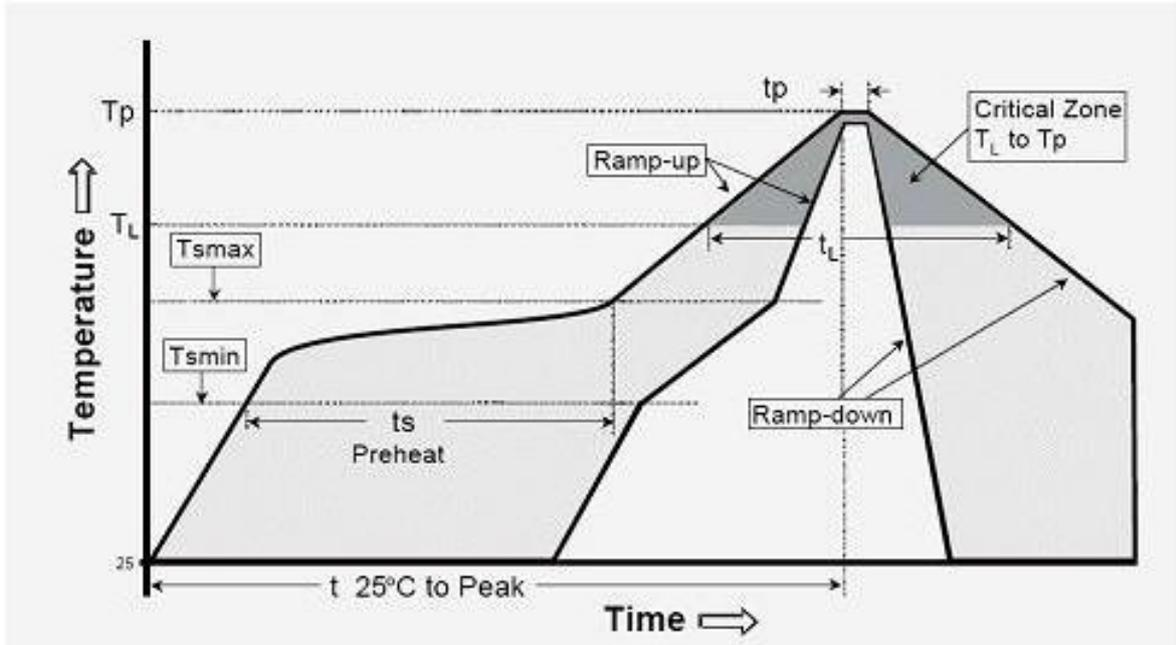

IPC/JEDEC J-STD-020B the condition for lead-free reflow soldering	big size components (thickness $\geq 2.5\text{mm}$ )
The ramp-up rate ( $T_L$ to $T_p$ )	3°C/s (max.)
preheat temperature	
- Temperature minimum ( $T_{smin}$ )	150°C
- Temperature maximum ( $T_{smax}$ )	200°C
- preheat time ( $t_s$ )	60~180s
Average ramp-up rate ( $T_{smax}$ to $T_p$ )	3°C/s (Max.)
- Liquidous temperature ( $T_L$ )	217°C
- Time at liquidous ( $t_L$ )	60~150 second
peak temperature ( $T_p$ )	245+/-5°C